

Atlantis ALG 654 Specifications

- 2 x 90mm Wastes with Basket Strainer Wastes. Capable of adaptation to take Waste Disposal Unit
- Waste in half bowl positioned to rear
- 4 colours of bespoke accessories available plus Stainless Steel
- Recessed drainer with dedicated convenient horizontal overflow
- Modern attractive design
- Large diagonal bowl dimension. Extra large main and half bowl located at front rim of sink profile
- Available as a Designer Value Pack

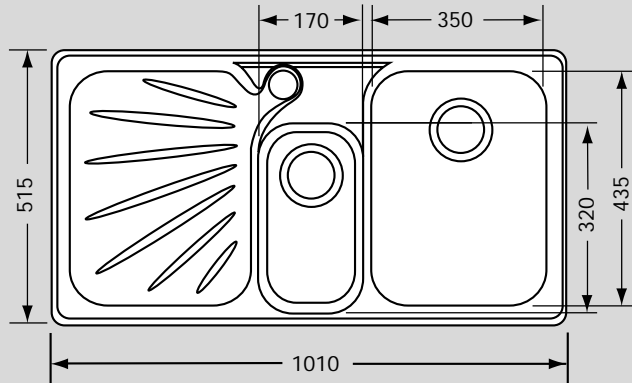

Material: Fraganite fused silica/quartz composite

Application: Inset

Bowl size: 350 x 435 x 180
170 x 320 x 135

Drainer Format: Left or right hand available

Cut-out size: 990 x 495

Colour: Fraganite SilkSheen:
Polar White, Ivory, Platinum & Graphite

Seal: Mastic Sealant

Insulation: Integral

Heat Resistance: Up to 280°C

Earthing Point: Not applicable

Cabinet size: 600mm

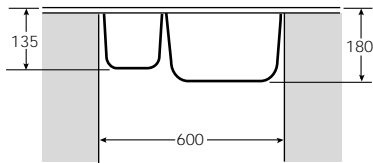

Fixing Clips: Attached

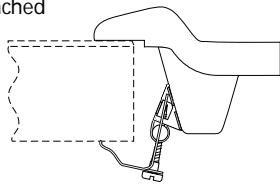

Suggested Plumbing Kit: 2 part

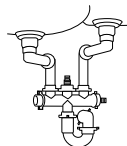

Waste: 2 x Lira 90mm Basket Strainer Waste with overflow

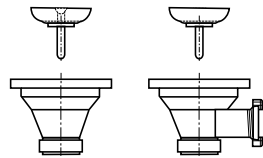

Overflow:

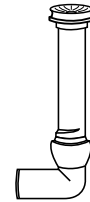

Accessories available:



Chopping Board Iroko Large

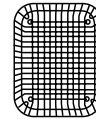

Drainer Basket Available in White, Almond, Brown or Black



Drainer Tray Available in White, Almond, Brown or Black



Drainer Tray Stainless Steel

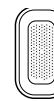

Strainer Bowl Available in White, Almond, Brown or Black



Strainer Bowl Stainless Steel

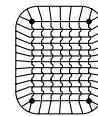

Drainer Basket Stainless Steel

Taps: Any Franke tap can be utilised with this model*.

*Ceramic disc taps in certain installations or where there is a low head of water (below 3 metres) may not provide adequate flow rates. You are advised to check with your supplier.

Guarantee: Franke sinks are guaranteed for 25 years against manufacturing defect. Franke taps are guaranteed against defective materials and workmanship for 1 year in relation to coatings and finishes, and 5 years in relation to moving parts. Franke will replace (and where appropriate repair) defective sinks. In relation to taps, Franke will where appropriate provide replacement parts for your taps or replace your taps. Any associated or ancillary costs to be incurred by you as a result of replacement of Franke sinks and taps under this guarantee shall in all cases be previously approved by Franke UK Limited.

This guarantee is in addition to and does not affect your statutory rights.